

手控器

HS12

HS12手控器按键数最多12键，且最多可驱动4支推杆。可依需求选配护士锁来锁住按键，以防止病人不当操作，主要适用于医疗领域。



产品特性及选项

- 主要应用领域：医疗照护
- 最多驱动推杆数：4支推杆
- 最多按键数：12按键
- 壳体颜色：浅灰色 (RAL7035)
- 手控线长：总长880mm±20mm，卷线长度420mm
- 防水等级：IPX6
- 附挂勾
- 配置LED指示灯
- 可选护士锁

机构尺寸

• 标准版本(无护士锁)

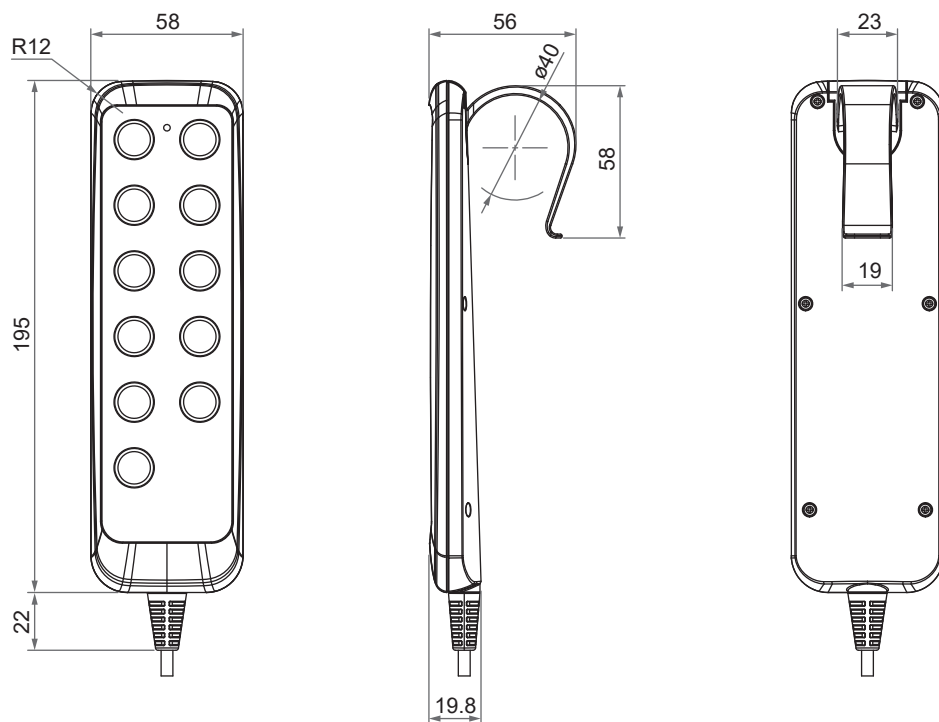

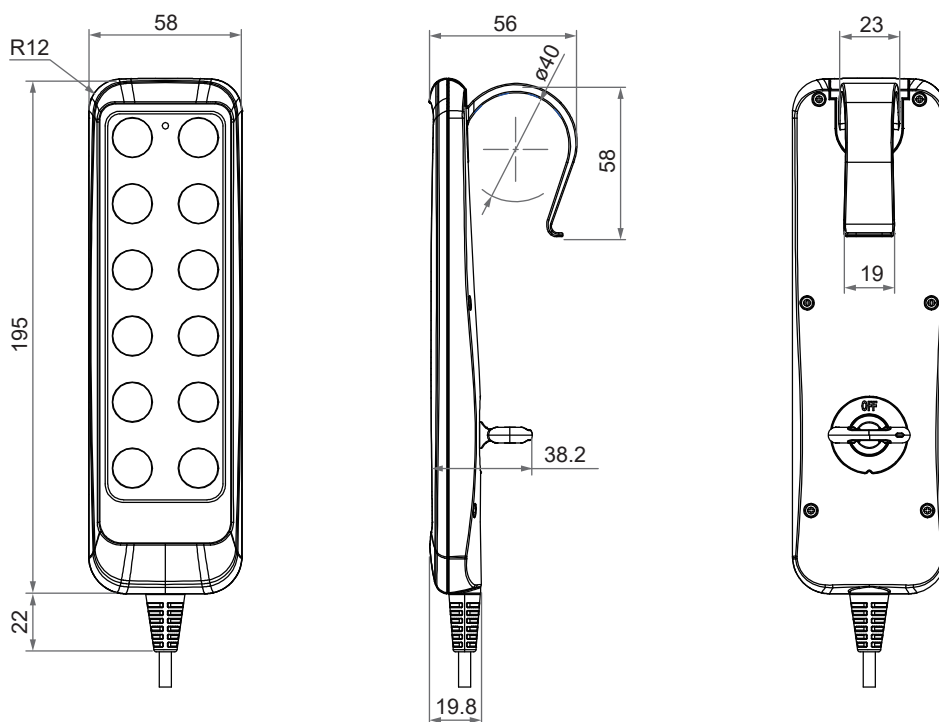

• 有护士锁版本



标准铭板选项

• 定义1

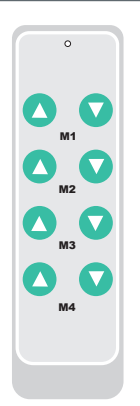
铭板代码	A	D	I*
铭板样式			

按键定义:

铭板代码A, D, I

- ① 推杆#1伸出
- ② 推杆#1缩回
- ③ 推杆#2伸出
- ④ 推杆#2缩回
- ⑤ 推杆#3伸出
- ⑥ 推杆#3缩回
- ⑦ 推杆#4伸出
- ⑧ 推杆#4缩回
- ⑨ CPR键：所有推杆缩回

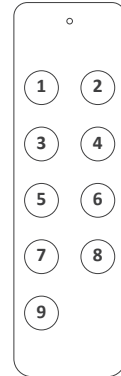

• 定义2

铭板代码	B
铭板样式	

铭板代码B

- ① 推杆#1伸出
- ② 推杆#1缩回
- ③ 推杆#2伸出
- ④ 推杆#2缩回

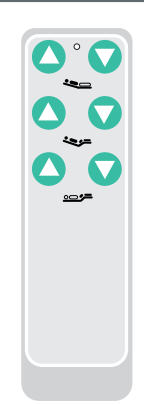
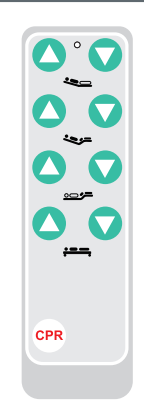
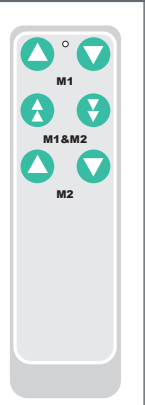
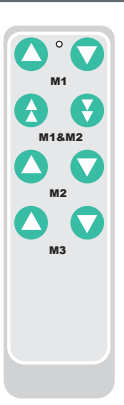

• 定义3

铭板代码	C	E	G*	H*
铭板样式				

铭板代码C, E, G, H

- ① 推杆#1伸出
- ② 推杆#1缩回
- ③ 推杆#1&2伸出
- ④ 推杆#1&2缩回
- ⑤ 推杆#2伸出
- ⑥ 推杆#2缩回
- ⑦ 推杆#3伸出
- ⑧ 推杆#3缩回
- ⑨ CPR键：所有推杆缩回

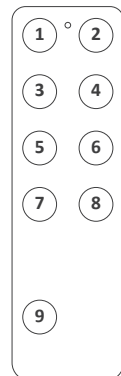

*代码G, H, I, J, K, L是有护士锁选项的铭板。

• 定义4

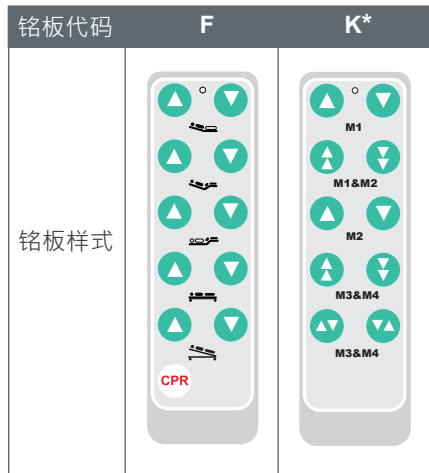

按键定义:

铭板代码F, K

- ① 推杆#1伸出
- ② 推杆#1缩回
- ③ 推杆#1&2伸出
- ④ 推杆#1&2缩回
- ⑤ 推杆#2伸出
- ⑥ 推杆#2缩回
- ⑦ 推杆#3&4伸出
- ⑧ 推杆#3&4缩回
- ⑨ 推杆#3伸出·#4缩回
- ⑩ 推杆#3缩回·#4伸出
- ⑪ CPR键: 所有推杆缩回

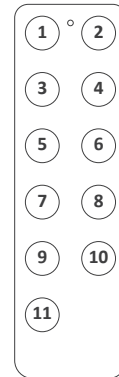

• 定义5

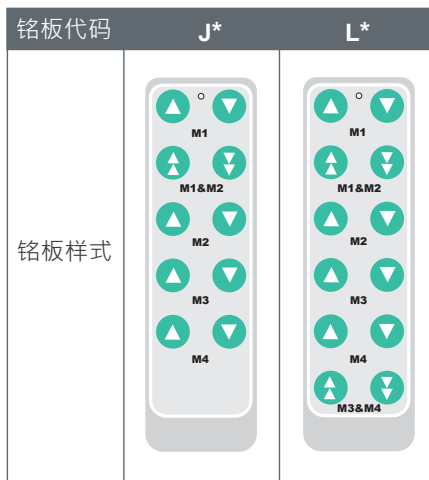

铭板代码J, L

- ① 推杆#1伸出
- ② 推杆#1缩回
- ③ 推杆#1&2伸出
- ④ 推杆#1&2缩回
- ⑤ 推杆#2伸出
- ⑥ 推杆#2缩回
- ⑦ 推杆#3伸出
- ⑧ 推杆#3缩回
- ⑨ 推杆#4伸出
- ⑩ 推杆#4缩回
- ⑪ 推杆#3&4伸出
- ⑫ 推杆#3&4缩回



*代码G, H, I, J, K, L是有护士锁选项的铭板。

相容性

产品	型号	相容条件
控制盒	CB2P, CB4P, CB4P-HP, MD6C, MD7C, MD80M, CM45	- MOTECK P1通讯类别 - 配Moteck H型或V型DIN插头

插头型式

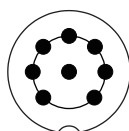

8-pin DIN插头



H型



V型

产品型号编码

HS12 - 08 - 3 - N H 0 0 8

按键数	02~12: 2~12按键
推杆数	1: 1推杆 2: 2推杆 3: 3推杆 4: 4推杆
护士锁	0: 无护士锁 N: 有护士锁
标准铭板选项	A~L: 请参考 标准铭板选项
保留码	0
保留码	0
手控线长	8: 总线长880mm±20mm ; 卷线长度420mm

护士锁功能说明



护士锁：

调到OFF，所有按键功能锁住无法操作，
调到ON即恢复正常操作。

