

手控器 HD

HD手控器按键数最多8键，可相容模帝科多款控制盒，适合应用于家具领域。



产品特性及选项

- 主要应用领域：家具
- 按键数：最多8个
- 壳体颜色：黑色
- LED指示灯
- 配置挂勾，方便用户挂置手控器
- 电源线长度：总长880mm含420mm的卷线
- 可选30mm/50mm挂勾

相容性

产品	型号	相容条件
控制盒	CF11H	- 配Moteck E2-type RJ插头
	CF12H	- 配Moteck E-type RJ插头
	T control, CBT2, CB3T, CB4M, CS1, CS2	- 配Moteck F-type DIN插头
船型电机	TW61	- 配Moteck A-type DIN插头

插头型式

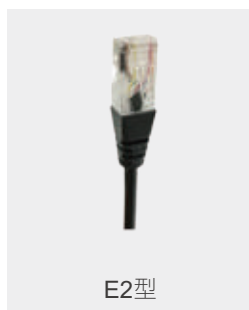

机构尺寸

- 配30mm标准挂勾

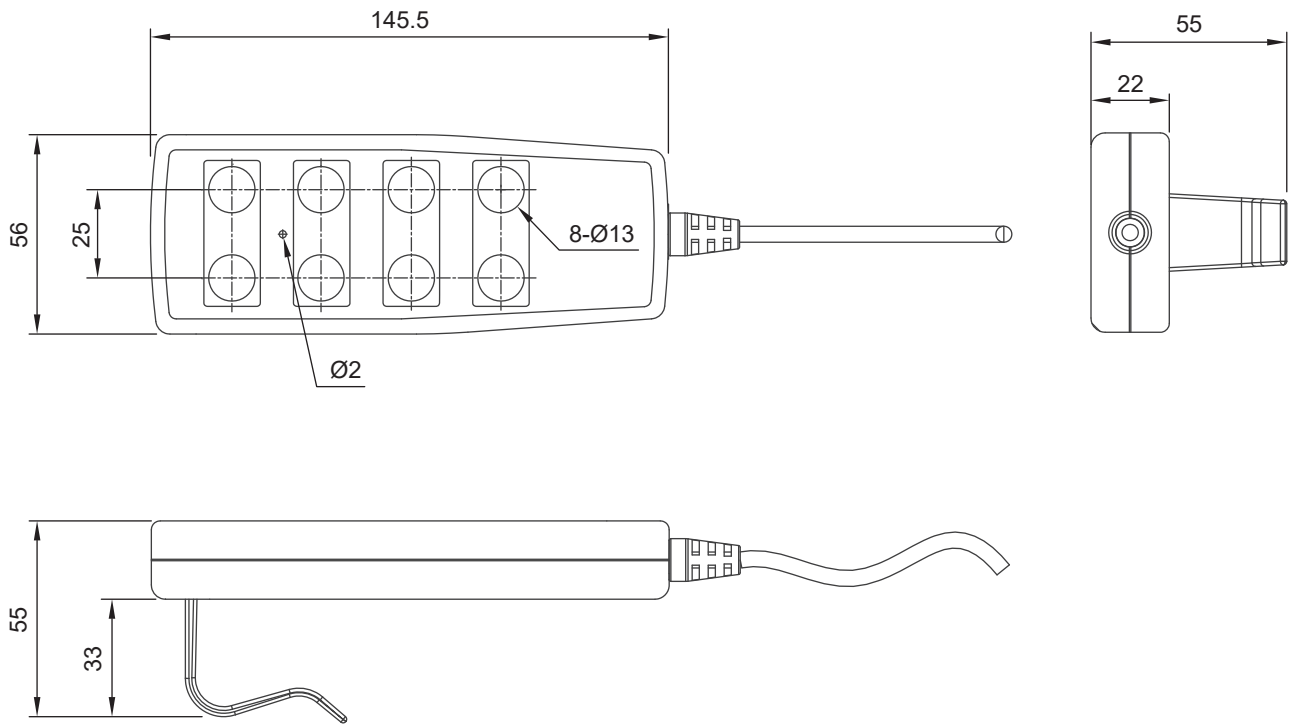

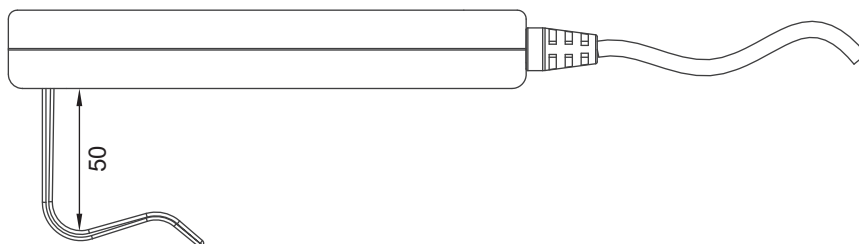

- 配50mm挂勾



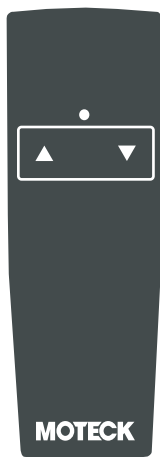
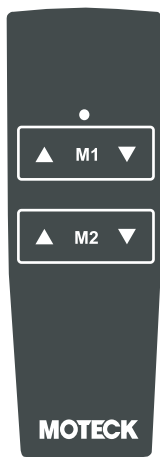

标准铭板选项

> Moteck P1通讯类别

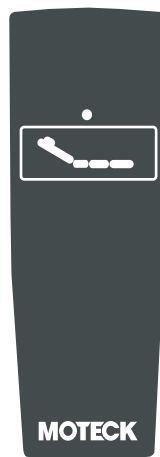
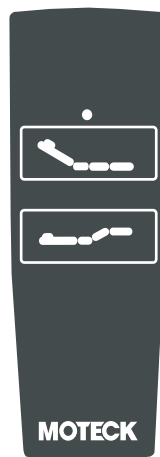
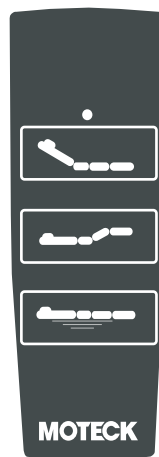
▶ 按键定义 1 (铭板样式A, C, F, J, L, O)

代码	A	C	F	J	L	O
铭板样式						
	HD-02-1-00	HD-04-2-00	HD-06-3-00	HD-02-1-00	HD-04-2-00	HD-06-3-00

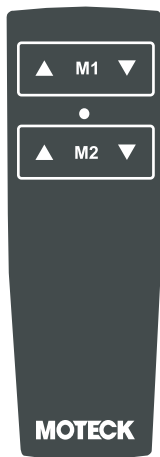
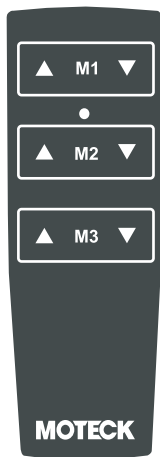
▶ 按键定义 2 (铭板样式B, E, I, K, N)

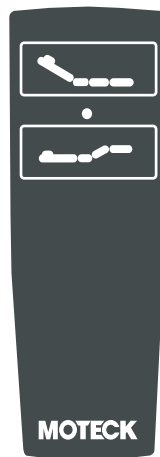
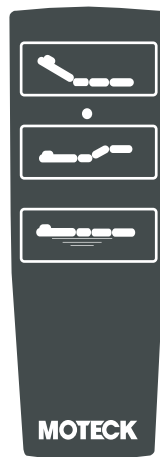
代码	B	E	I	K	N
铭板样式					
	HD-04-2-00	HD-06-3-00	HD-08-4-00	HD-04-2-00	HD-06-3-00

- 按键定义1 (铭板样式A, C, F, J, L, O)

- ① 推杆#1伸出
- ② 推杆#1缩回
- ③ 推杆#2伸出
- ④ 推杆#2缩回
- ⑤ 推杆#3伸出
- ⑥ 推杆#3缩回

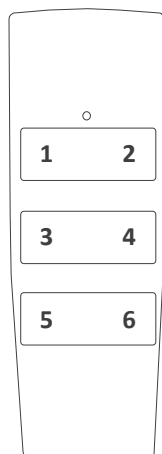

- 按键定义2 (铭板样式B, E, I, K, N)

- ① 推杆#1伸出
- ② 推杆#1缩回
- ③ 推杆#2伸出
- ④ 推杆#2缩回
- ⑤ 推杆#3伸出
- ⑥ 推杆#3缩回
- ⑦ 推杆#4伸出
- ⑧ 推杆#4缩回



▶ 按键定义3 (铭板样式D, G, M, P)

代码	D	G	M	P
铭板样式				
	HD-06-2-01	HD-08-3-01	HD-06-2-01	HD-08-3-01

▶ 按键定义4 (铭板样式H, Q)

代码	H	Q
铭板样式		
	HD-08-3-01	HD-08-3-01

- 按键定义3 (铭板样式D, G, M, P)

- ① 推杆#1伸出
- ② 推杆#1缩回
- ③ 推杆#1 & 2伸出
- ④ 推杆#1 & 2缩回
- ⑤ 推杆#2伸出
- ⑥ 推杆#2缩回
- ⑦ 推杆#3伸出
- ⑧ 推杆#3缩回

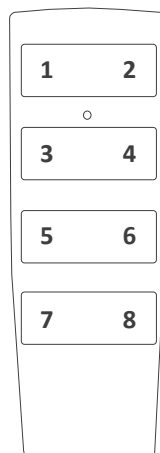

- 按键定义4 (铭板样式H, Q)

- ① 推杆#1伸出
- ② 推杆#1缩回
- ③ 推杆#2伸出
- ④ 推杆#2缩回
- ⑤ 推杆#1 & 2伸出
- ⑥ 推杆#1 & 2缩回
- ⑦ 推杆#3伸出
- ⑧ 推杆#3缩回

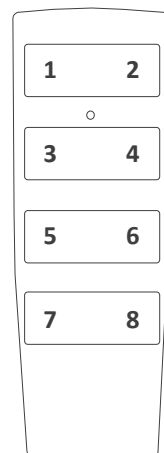

型号编码

HD - 04 - 2 - 0 B 3 0 8

按键数	02: 2按键 04: 4按键 06: 6按键 08: 8按键
推杆数	1: 1推杆 2: 2推杆 3: 3推杆 4: 4推杆
保留码	0
铭板样式	A~Q: (请参考 标准铭板选项)
配件	3: 间距30mm挂勾(标准) 5: 间距50mm挂勾
保留码	0
电源线长	8: 总长880mm含420mm的卷线