

手控器

H3T-M

H3T-M是属于模帝科特有Bus通讯协议的手控器，带有10个按键可透过软件根据不同的客户需求来定义功能，适用于先进的医疗机构及家庭护理之应用。



产品特性及选项

- 主要应用领域：医疗照护
- 按键数：最多10个
- 防护等级：IPX4
- 配置间距30mm挂勾，方便用户挂置手控器
- 壳体颜色：浅灰色(RAL 7035)
- 电源线长度：总长880mm含420mm的卷线
- 可选间距50mm挂勾

相容性

产品	型号	相容条件
控制盒	MD6C-M	- 配Moteck H型或V型7-pin DIN 插头
	CB5P-M, CM41-M	- 配Moteck V型7-pin DIN 插头
配件	JB1, JB3集线盒 · SB1急停按钮	- 配Moteck H型7-pin DIN 插头

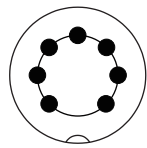

7-pin DIN 插头



H型



V型

- 模帝科Bus家族

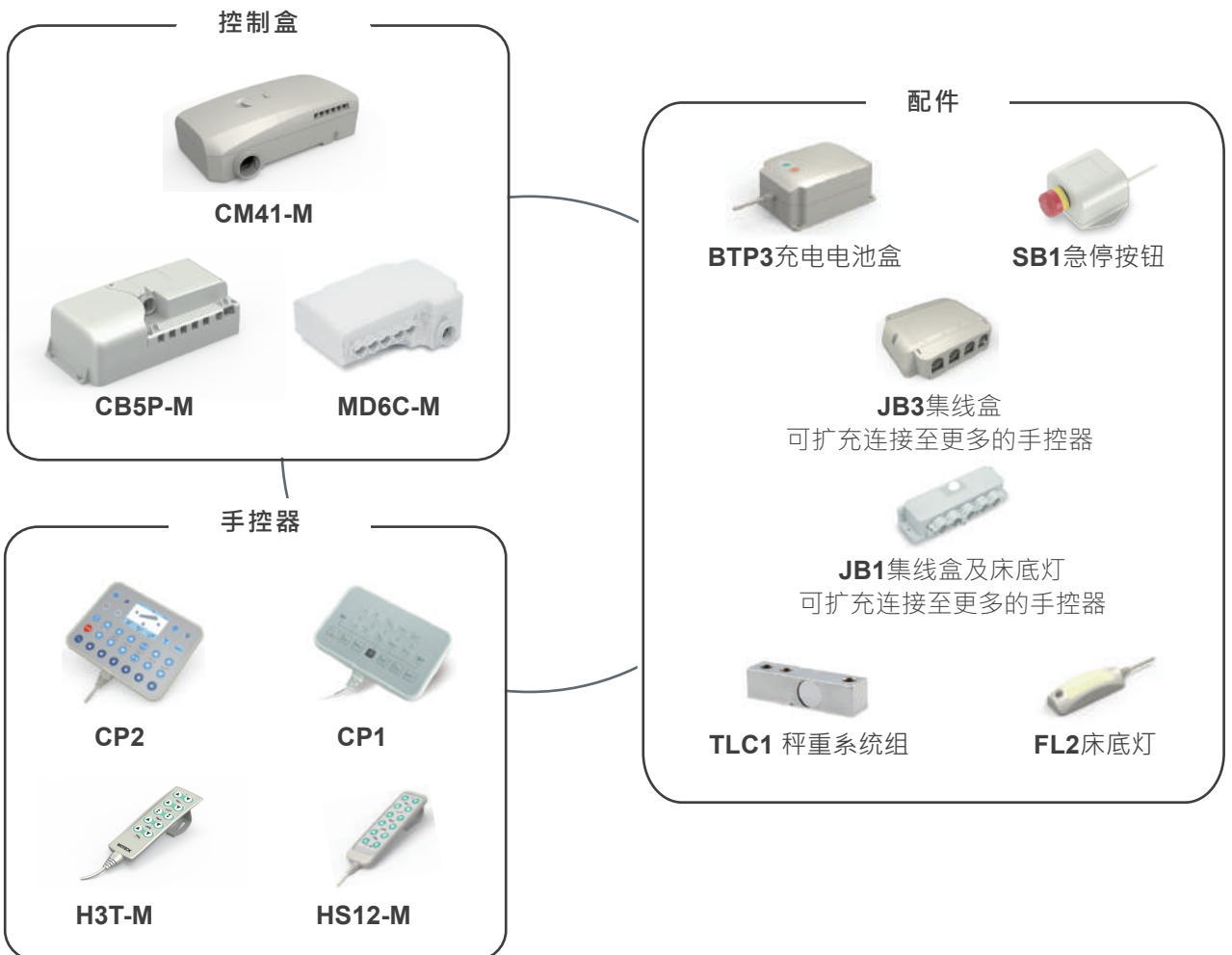

机构尺寸

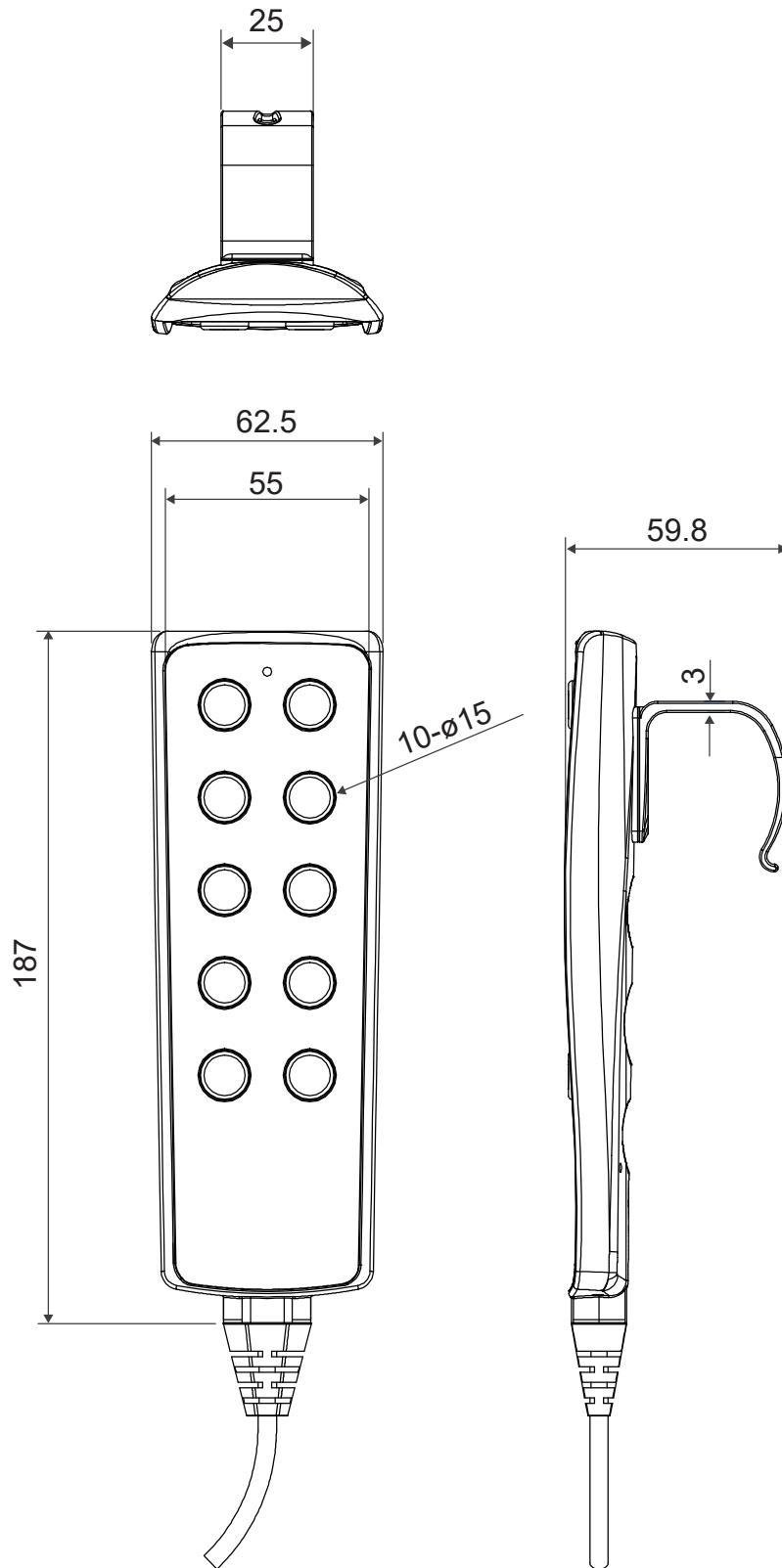

标准铭板选项

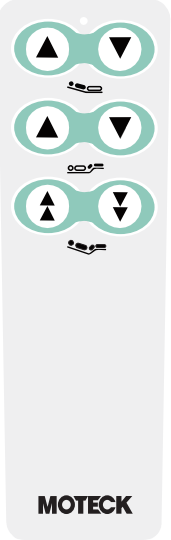
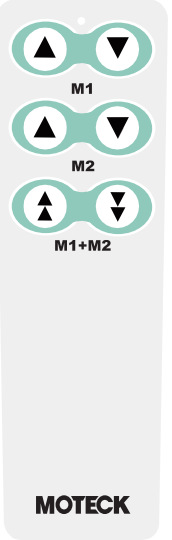
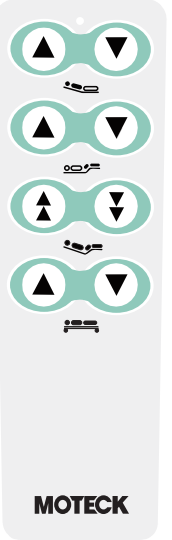
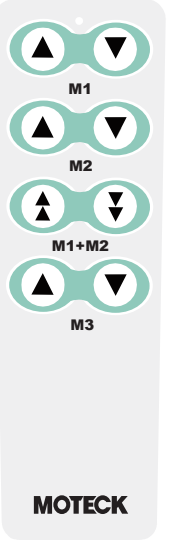
代码	A		B		C		D	
驱动推杆数	2推杆同动		2推杆同动		3推杆同动		3推杆同动	
按键定义	1+	1-	1+	1-	1+	1-	1+	1-
	2+	2-	2+	2-	2+	2-	2+	2-
	1+2+	1-2-	1+2+	1-2-	1+2+	1-2-	1+2+	1-2-
					3+	3-	3+	3-
铭版样式	 <p>MOTECK</p>		 <p>MOTECK</p>		 <p>MOTECK</p>		 <p>MOTECK</p>	

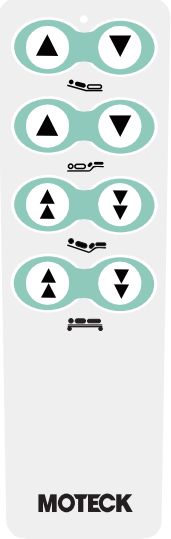
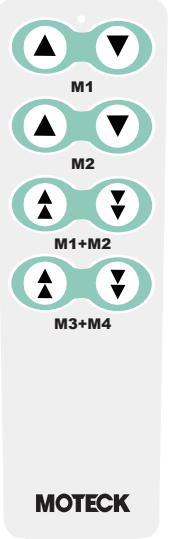
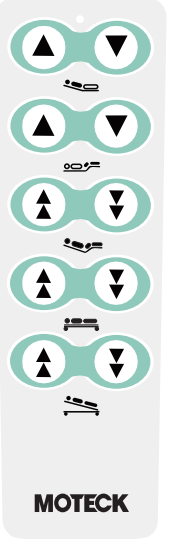
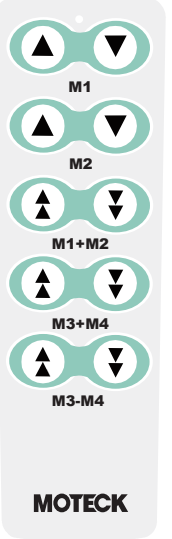
代码	E		F		G		H	
驱动推杆数	4推杆同动		4推杆同动		4推杆同动		4推杆同动	
按键定义	1+	1-	1+	1-	1+	1-	1+	1-
	2+	2-	2+	2-	2+	2-	2+	2-
	1+2+	1-2-	1+2+	1-2-	1+2+	1-2-	1+2+	1-2-
	3+4+	3-4-	3+4+	3-4-	3+4+	3-4-	3+4+	3-4-
					3+4-	3-4+	3+4-	3-4+
铭版样式	 <p>MOTECK</p>		 <p>MOTECK</p>		 <p>MOTECK</p>		 <p>MOTECK</p>	

产品型号编码

H3T-M - 08 - 3 E V - 0 0

按键数	06: 6键 08: 8键 10: 10键
挂勾	3: 间距30mm挂勾(标准) 5: 间距50mm挂勾
铭板样式	A~H (请参考 标准铭板选项)
插头型式	V: V型DIN插头 H: H型DIN插头
保留码	0
保留码	0