

# Hand Control H3F

H3F hand control has up to 8 buttons, with key backlight function, convenient to use in dark places. It is suitable for use in furniture and medical care equipment.



## Features and Option

---

- Main applications: Furniture, Medical care
- Available actuator number to control: 3 max.
- Available number of buttons: 8 max.
- IP level: IPX4
- Color: Dark gray (Pantone 446C)
- Back light color: Blue
- With hook for easy placement
- Cable length: Total 880mm long with 420mm spiral
- Optional IPX6 level

## Compatibility

Product	Model	Compatible requirement
Control box	CM45	- Moteck P1 control category - With Moteck H-type DIN plug
	CB2P, CB4P, CB4M, MD6C, MD7C, MD80M	- Moteck P1 control category - With Moteck H-type or V-type DIN plug

### Cable plug

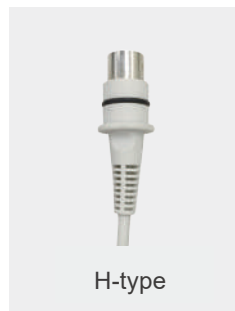

# Dimensions

Unit: mm

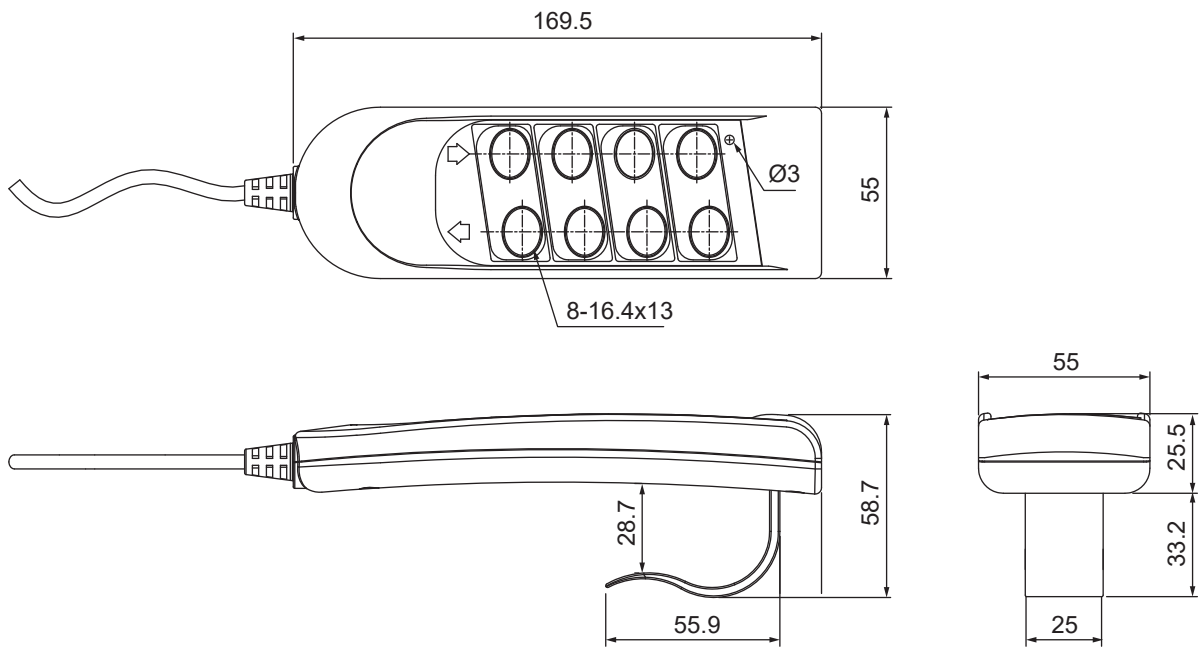

# Standard Panel Artwork

## ► Definition 1 (artwork A, B, E)

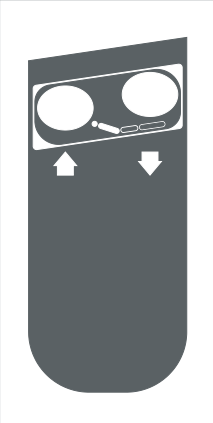
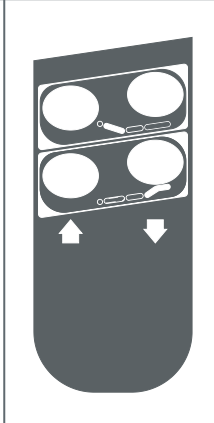
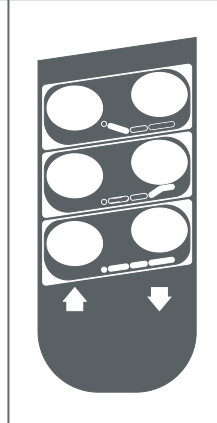
Code	A	B	E
Artwork			

### Button definition:

- ① Actuator #1 extends
- ② Actuator #1 retracts
- ③ Actuator #2 extends
- ④ Actuator #2 retracts
- ⑤ Actuator #3 extends
- ⑥ Actuator #3 retracts

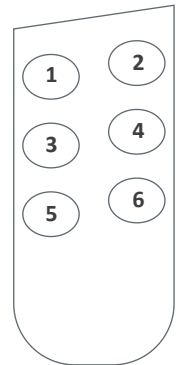

## ► Definition 2 (artwork C, D, F)

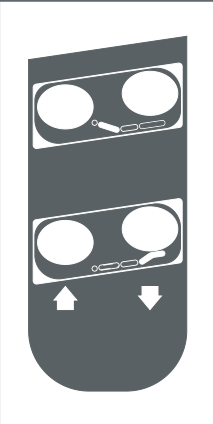
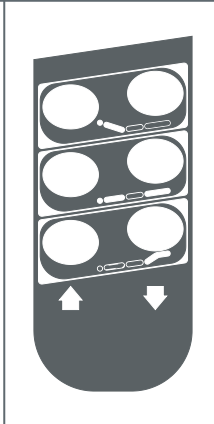
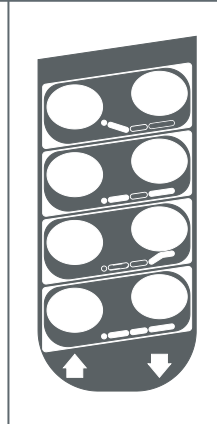
Code	C	D	F
Artwork			

### Button definition:

- ① Actuator #1 extends
- ② Actuator #1 retracts
- ③ Actuator #1 & 2 extend
- ④ Actuator #1 & 2 retract
- ⑤ Actuator #2 extends
- ⑥ Actuator #2 retracts
- ⑦ Actuator #3 extends
- ⑧ Actuator #3 retracts

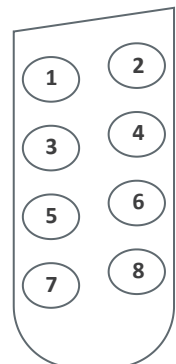

## ► Definition 3 (artwork G)

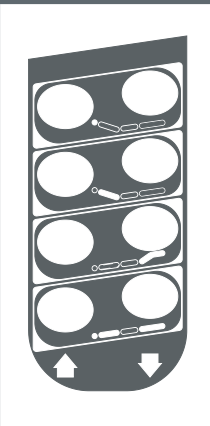
Code	G
Artwork	

### Button definition:

- ① Actuator #1 extends
- ② Actuator #1 retracts
- ③ Actuator #2 extends
- ④ Actuator #2 retracts
- ⑤ Actuator #3 extends
- ⑥ Actuator #3 retracts
- ⑦ Actuator #1 & 2 & 3 extend
- ⑧ Actuator #1 & 2 & 3 retract

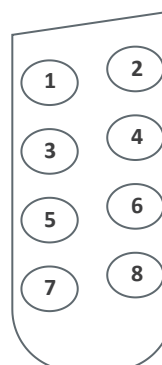

# Ordering Key

**H3F - 04 - 2 - 0 B 0 6 0**

<b>Button</b>	<b>02:</b> 2 buttons <b>04:</b> 4 buttons <b>06:</b> 6 buttons <b>08:</b> 8 buttons
<b>Number of motor</b>	<b>1:</b> 1 motor <b>2:</b> 2 motors <b>3:</b> 3 motors
<b>Reserved</b>	<b>0</b>
<b>Panel artwork code</b>	<b>A~G:</b> (Refer to Standard Panel Artwork)
<b>Reserved</b>	<b>0</b>
<b>IP level</b>	<b>4:</b> IPX4 (standard) <b>6:</b> IPX6
<b>Cable length</b>	<b>8:</b> Total 880mm long with 420mm spiral

**Terms of Use**

The user is responsible for application suitability of Moteck products. As ongoing improvement process continues, products listed on the Moteck website are subject to change without prior notice. Moteck reserves the right to terminate the sales or remove any product displayed on the website, or listed in its catalogues.