

# Battery Box

## BTP2-L

BTP2-L is a rechargeable battery box containing 4000mAh Lithium ion batteries. It can be used as a main power source for mobile applications, and suitable for use in medical care.



## Features

---

**Main applications:** Medical Care

- Contains Lithium ion batteries with capacity of 4000mAh
- Output voltage: 25.6V DC
- Rated output current: 6A
- Overload protection
- Battery level indicator
- IP level: IPX6
- With specified charger (AC power cords need to be ordered separately)
- With parts kit (DJ7021-2-11 connector)
- Color: Light gray (RAL 7035)

## Compatibility

Product	Model	Compatible requirement
Control box	CM23	<ul style="list-style-type: none"><li>DJ7021-2-11 connector (male)</li></ul>



DJ7021-2-11 connector (male)

## Dimensions

Unit: mm

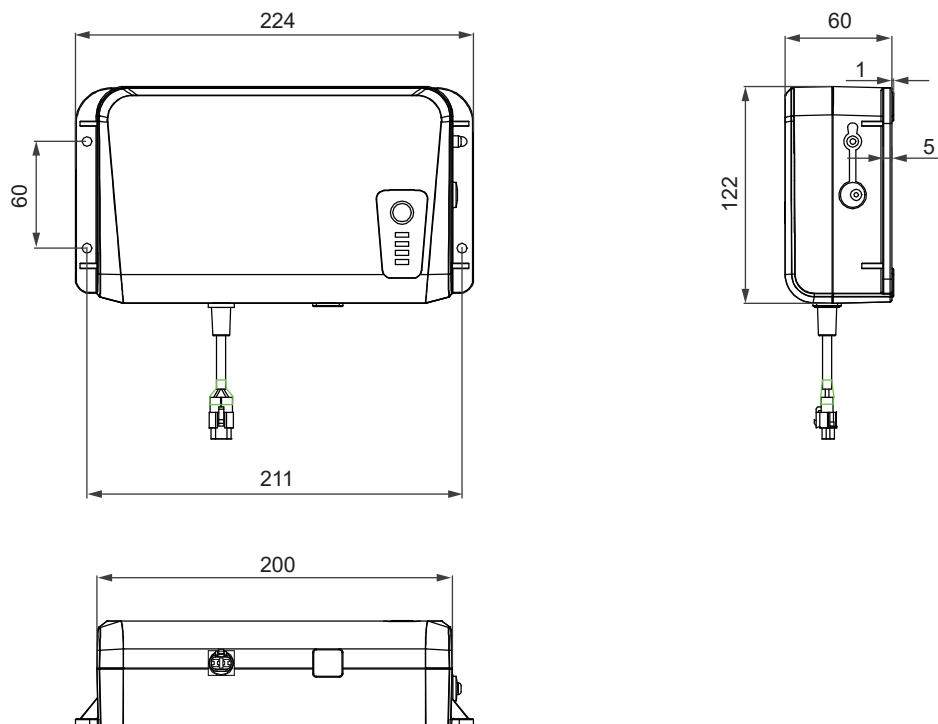

## Instruction

---

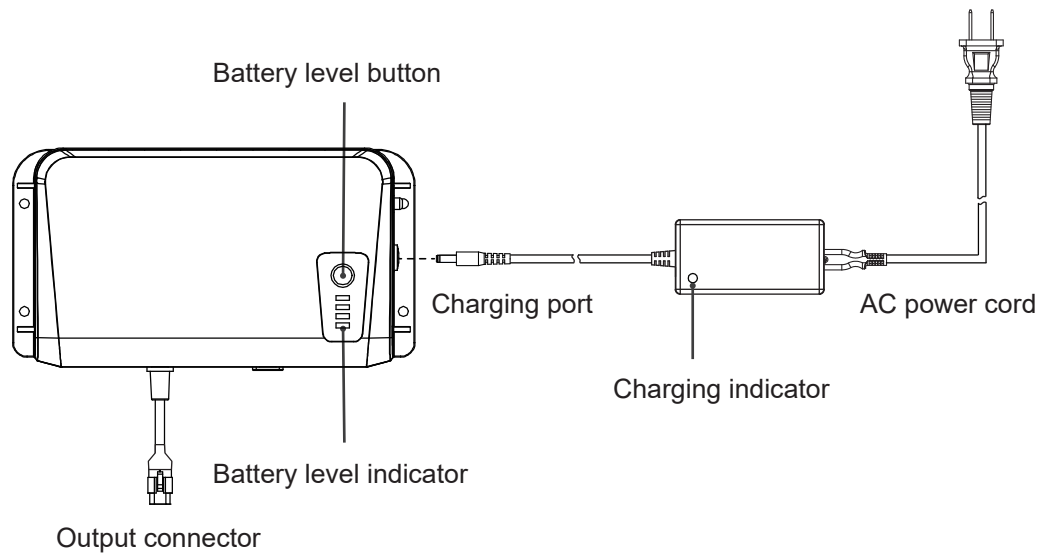





- **ON/OFF:**

- **ON:** In the OFF state, press and hold the battery level button for about 3 seconds until the battery level indicator lights up and release the button. At this time, the battery level indicator flashes slowly for about 5 seconds according to the corresponding power level, and then turns into a constant four-bar light, indicating that the output function is ON. After about 5 seconds, the four-bar indicator turns off, and the output is continued until it is turned off.
- **OFF:** In the ON state, press and hold the battery level button for about 3 seconds until the battery level indicator lights up and release the button. At this time, the indicator stays on for about 5 seconds and then turns off to stop the output.

- **Check the battery level:**

- In the ON state, briefly press the ON/OFF button and then release the button. The battery level indicator stays on for about 5 seconds according to the corresponding power level and then off.
- In the OFF state, briefly press the ON/OFF button and then release the button. The battery level indicator flashes slowly for about 3 seconds according to the corresponding power level and then off.

● **Battery level status :**

Battery level bar	Status
	Full battery level
	About 75% battery level
	About 50% battery level
	Can barely use, but charge it when there is a chance.
	Need to charge immediately

● **Charging :**

- Open the waterproof plug of the charging port, connect the specified charger and plug into the power supply to start charging. At this time, the indicator on the charger lights red ● , and the battery level indicator flashes according to the corresponding power level.
- When the battery is full, the level bar will remain on for 4 bars, and the charging indicator will turn green ● to indicate that the charge is complete. Unplug the charger and put the waterproof plug back on to return to waterproof state.
- Avoid water on the battery box when charging, please note that the connection between the charger and the charging interface is not waterproof at this time.
- Do not use a non-specified charger for charging.

**Terms of Use**

The user is responsible for application suitability of Moteck products. As ongoing improvement process continues, products listed on the Moteck website are subject to change without prior notice. Moteck reserves the right to terminate the sales or remove any product displayed on the website, or listed in its catalogues.